

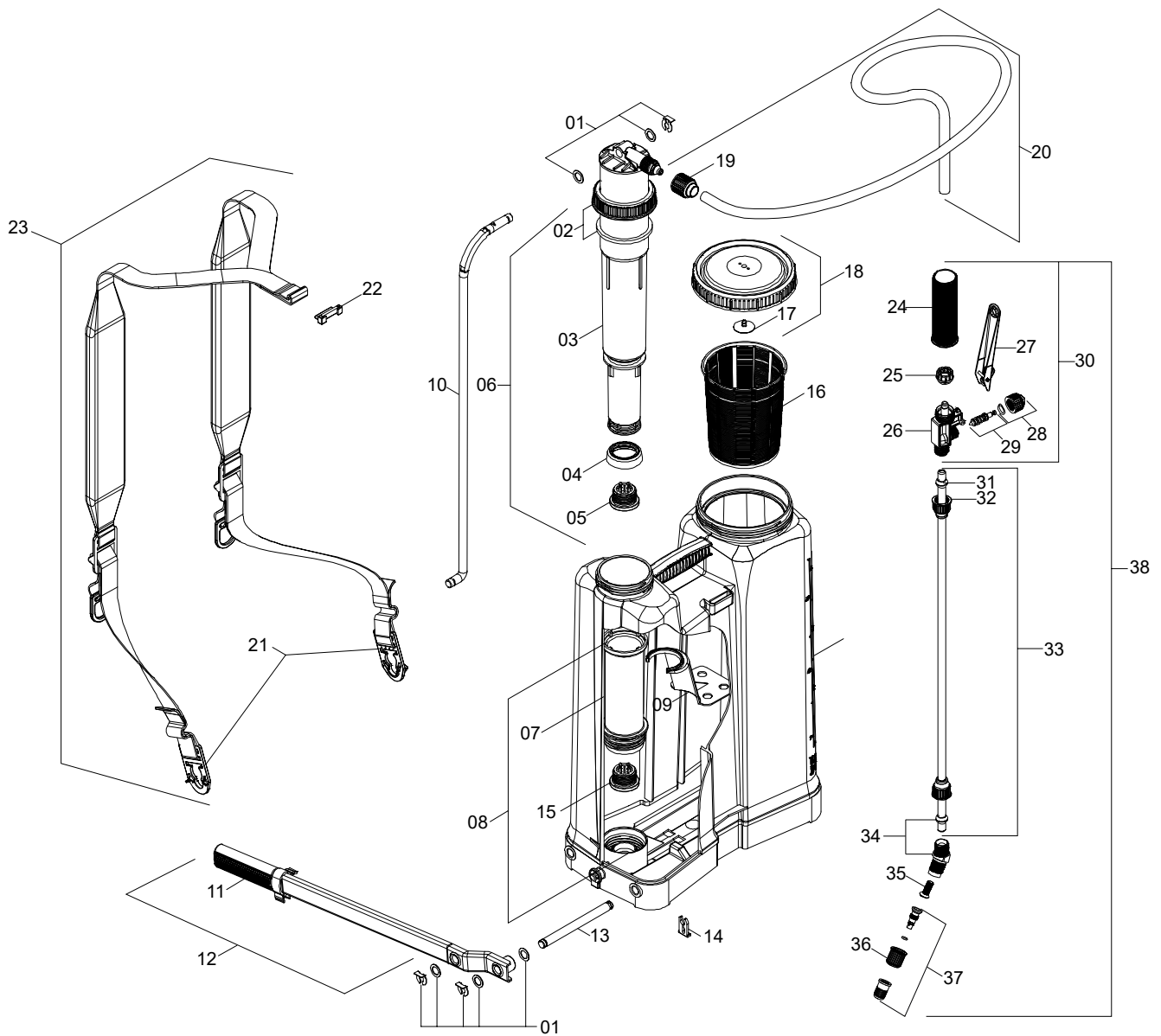

































PARTS CATALOG

JACTO HD-400



Nº	CODE	DESCRIPTION	IMAGE	QTY.	UTILIZATION	NCM HS CODE	EAN BARCODE
1	1198800	WASHERS AND LOCKED RINGS SET		1	PJ, PJH, XP, HD	7318.22.00	7909436961189
2	907121	GASKET HOLDER AND GASKET HD		1	HD	3926.90.90	7899144843856
3	951053	CHAMBER BODY AND PISTON CUP U		1	HD	8424.90.90	789144874928
4	568535	PISTON CUP Ø45 X 12		1	HD	4016.93.00	7899144801047
5	1173630	FASTENER WITH SPHERE		1	HD	8424.90.90	7899144894414
6	635813	HD CHAMBER ASSEMBLY		1	HD	8424.90.90	7899144857136
7	635599	CYLINDER BODY HD		1	HD	8424.90.90	7896821558348
8	654939	CYLINDER ASSEMBLY WITH VALVE		1	HD	8424.90.90	7896821554043
9	214619	HD AGITATOR		1	HD	8424.90.90	7896821546802
10	1197400	ROD WITH LOCK		1	PJ, PJH, XP, HD	8424.90.90	7896660836980
11	495812	HANDGRIP WITH LOCK		1	PJ, PJH, XP, HD	8424.90.90	7896821573990
12	615005	PUMPING LEVER		1	PJ, PJH, XP, HD	8424.90.90	7896821509753
13	293324	LEVER SHAFT		1	XP, HD	7318.24.00	7896821509753
14	277350	SHAFT LOCK		1	XP, HD	8424.90.90	7896821567326
15	838011	CYLINDER VALVE ASSEMBLY		1	HD	8424.90.90	7899144858089
16	1220919	TANK STRAINER		1	PJ, HD, PJB, DJB	8424.90.90	7896660888309
17	1168542	LID DIAPHRAGM		1	PJH, PJ, XP, HD, PJB, DJB, DJB-S	4016.99.90	7909436909006

JACTO HD-400

Nº	CODE	DESCRIPTION	IMAGE	QTY.	UTILIZATION	NCM HS CODE	EAN BARCODE
18	1220918	LID AND DIAPHRAGM		1	PJ, HD, PJB, DJB, DJB-S	8424.90.90	7896660888286
19	942193	SCREW CAP S20 X 1,5		1	PJH, PJ, XP, HD, PJB, DJB, DJB-S	3926.90.90	7896821551912
20	048116	5/16" x 1650 BLACK FLEWX PVC HOSE		1	HD, CD-400	8424.90.90	7896821551837
21	1220973	HD BUCKLE		1	HD, PJB, DJB, DJB-S	8424.90.90	7909436915274
22	1222671	STRAP LOCK		1	HD	8424.90.90	7909436914642
23	1256384	PADDED STRAP BELT WITH ADJUSTMENT HD-400		1	HD-400	8424.90.90	7909436922777
24	1220962	TRIGGER VALVE HANDLE LP		1	PJH, PJ, HD, PJB, DJB	8424.90.90	7909436924115
25	1220966	CLIP LP 601		1	PJH, PJ, HD, PJB, DJB	3926.90.90	7909436924474
26	1220968	TRIGGER VALVE BODY LP 601		1	PJH, PJ, HD, PJB, DJB	8481.90.90	7909436924603
27	1220951	TRIGGER VALVE LEVER LP 601 P		1	PJH, PJ, HD, PJB, DJB	8424.90.90	7909436923989
28	996058	TRIGGER VALVE CAP LP 601/ 605 AND SEAL		1	PJH, PJ, CD, HD, PJB, DJB	8481.90.90	7909436923972
29	1230971	TRIGGER VALVE NEEDLE		1	PJH, PJ, CD, HD, PJB, DJB	8424.90.90	7896660860046
30	1217605	TRIGGER VALVE LP 601		1	PJH, PJ, CD, HD, PJB, DJB	8424.90.90	7896660870397
31	1220972	CONE PACKING		1	PJH, PJ, XP, HD, PJB, DJB, DJB-S	3926.90.90	7909436925037
32	1220969	SCREW CAP 11/16		1	PJH, PJ, XP, HD, PJB, DJB, DJB-S	3926.90.90	7909436924924
33	100131	STAINLESS STEEL LANCE		1	PJH, PJ, XP, HD, PJB, DJB	8424.90.90	7896821501252
34	635276	JOINT AND CONE PACKING		1	PJH, PJ, XP, HD, PJB, DJB, DJB-S	3917.40.90	7909436931311

Nº	CODE	DESCRIPTION	IMAGE	QTY.	UTILIZATION	NCM HS CODE	EAN BARCODE
35	1168545	NOZZLE FILTER M50/60		1	PJH, PJ, XP, HD, PJB, DJB, DJB-S	8424.90.90	7896660860053
36	1168546	NOZZLE CAP		1	PJH, PJ, XP, HD, PJB, DJB, DJB-S	8424.90.90	7909436925310
37	1222664	BLUE ADJUSTABLE CONE NOZZLE		1	PJH, PJ, XP, HD, PJB, DJB	8424.90.90	7909436928588
38	915769	LANCE AND TRIGGER VALVE		1	PJH, PJ, CD, HD PJB, DJB	8424.90.90	7909436917605